

# What you can do with...

a P300 3x1 Straight - also possible with curved frame

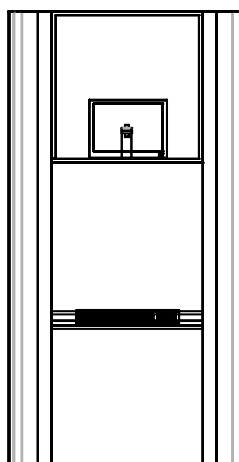
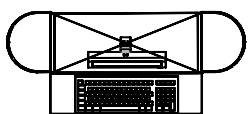
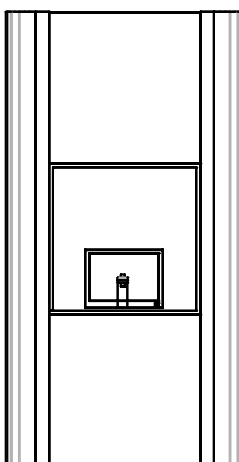
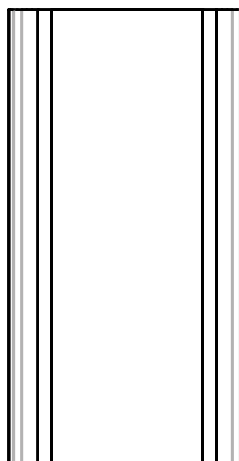
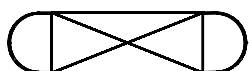

# What you can do with...

2 x P300 3x1 Flats - also possible with curved frames

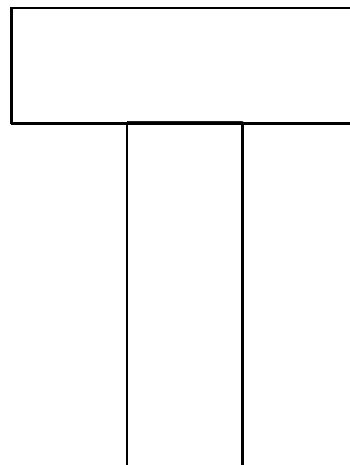
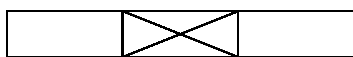
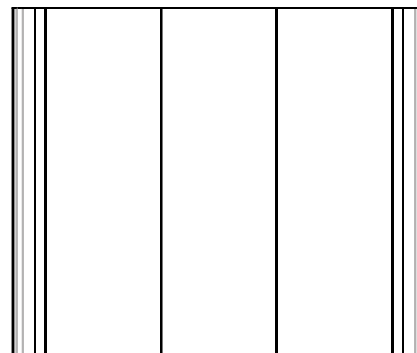
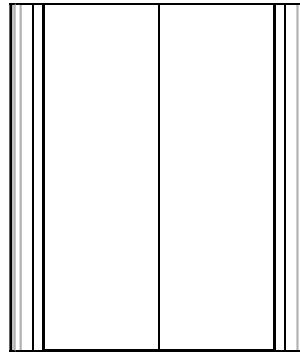
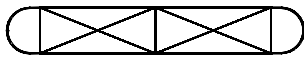
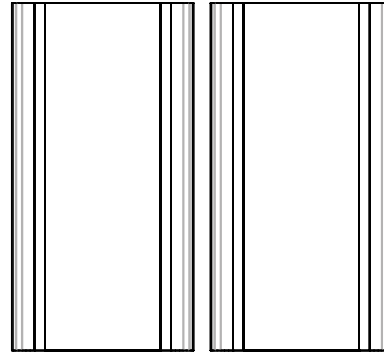

# What you can do with...

3 x P300 3x1 Flats - also possible with curved frames

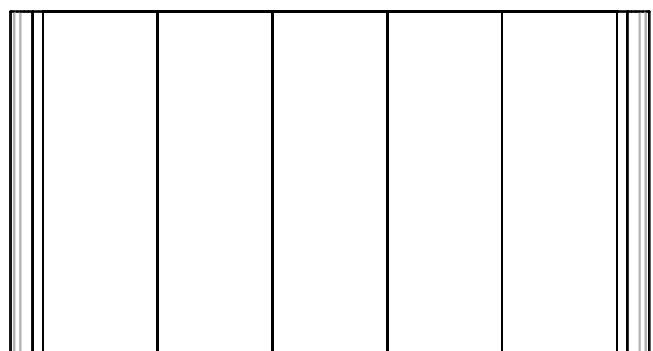
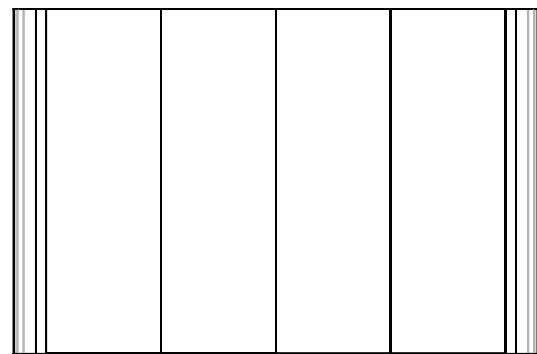
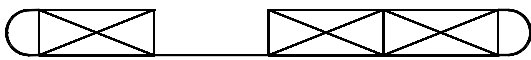
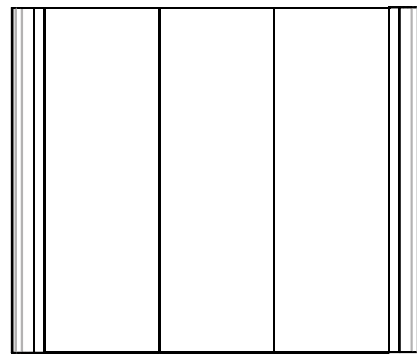
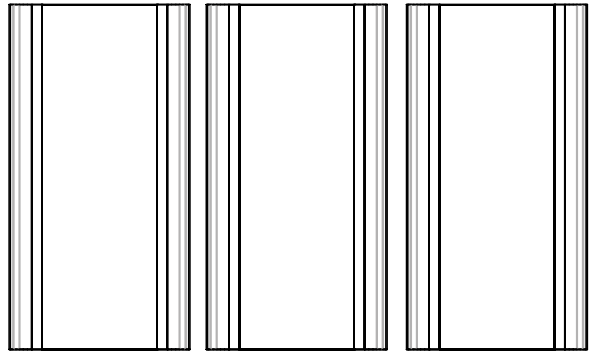

# What you can do with...

P300 Straights - also possible with curved frames

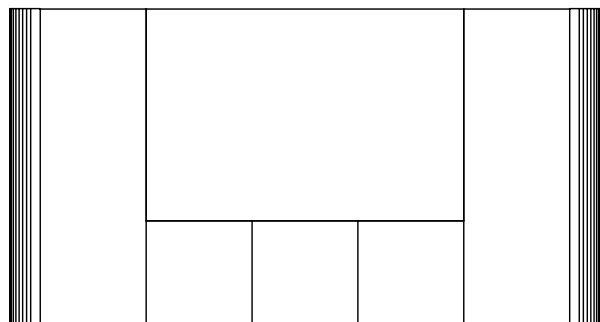
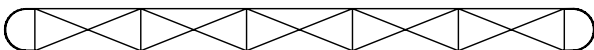
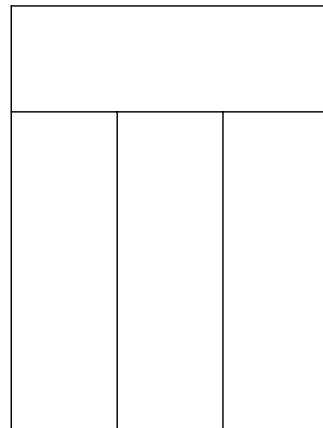
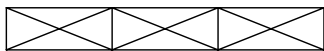
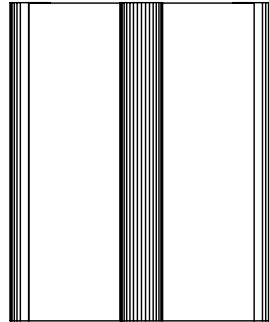
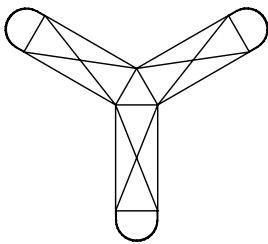
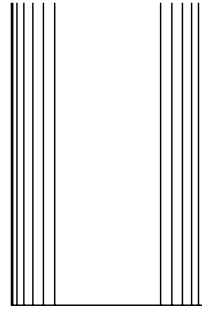
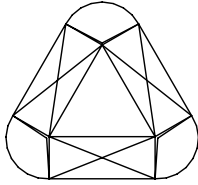

# What you can do with...

4 x P300 Straights - also possible with curved frames

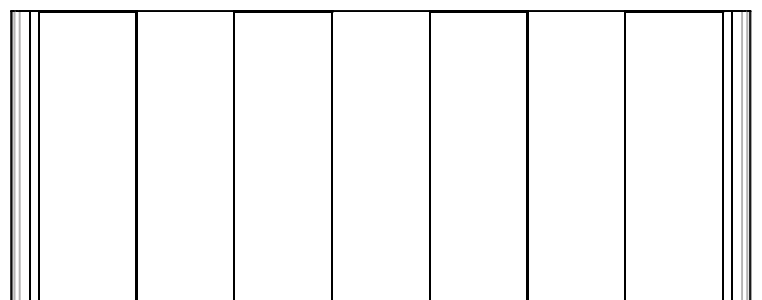
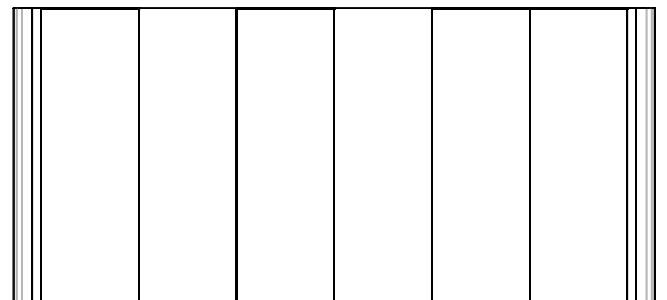
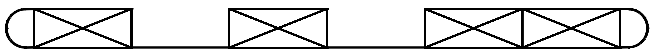
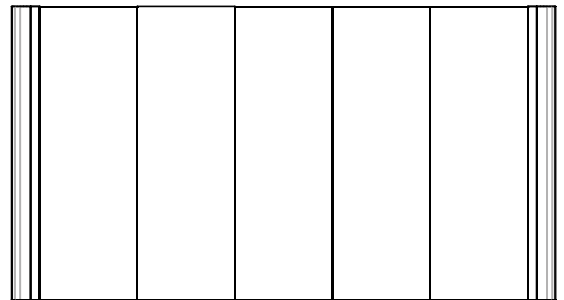
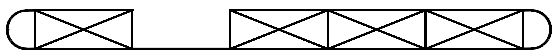
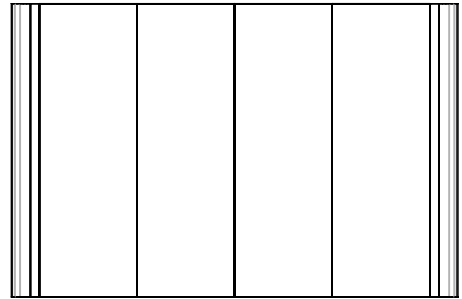
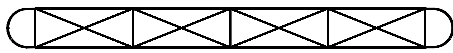

# What you can do with...

4 x P30 Straights - also possible with curved frames

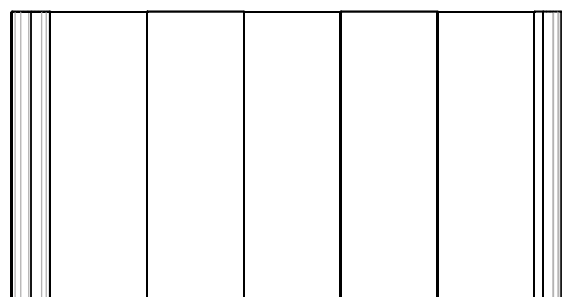
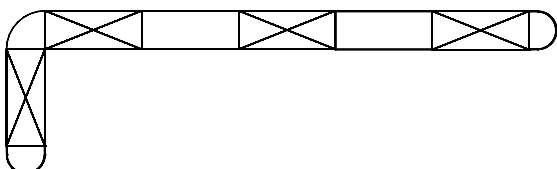
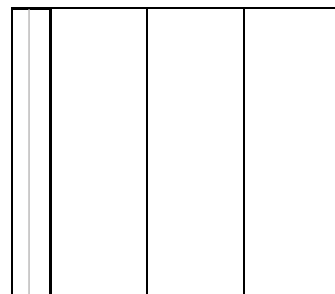
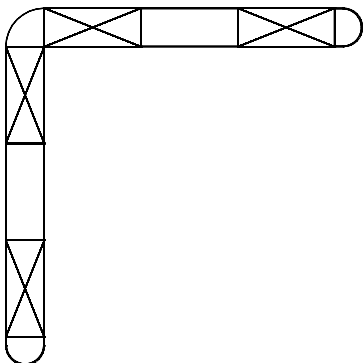
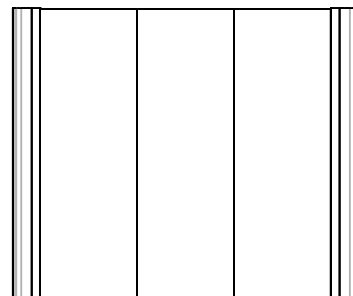
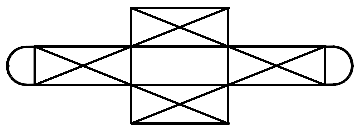
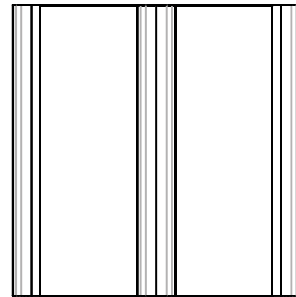
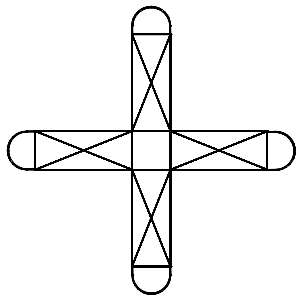
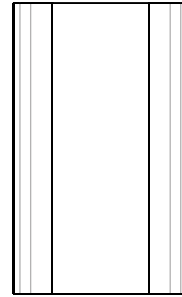
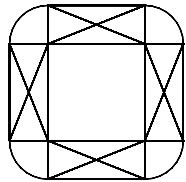

# What you can do with...

4 x P300 Straights - also possible with curved frames

